

Varenummer: 03446260
Beskrivelse: Fluro Heavy Duty Ledleje GE 260 GW-2RS
Hul Ø260
Note: 260

Mål

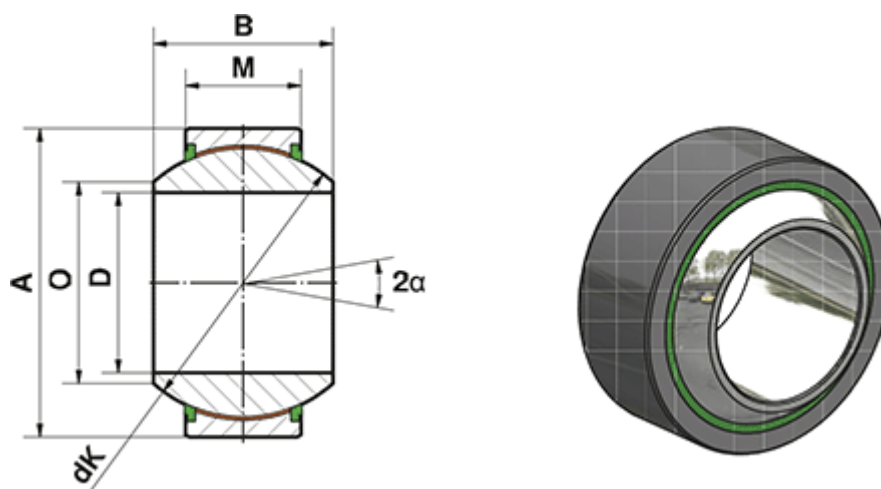

= -	Dynamisk belastning C (kN) = 10050
= -	M = 120
= -	O = 283.6
A = 400	Statisk belastning C0 (kN) = 16750
a (grader) = 15	Vægt (g) = 81800
B = 205	
D = 260	
dK = 350	